

AOYUE[®]

INT 474A++

Advanced Desoldering System

INSTRUCTION MANUAL

Thank you for purchasing Aoyue Int474A++ Desoldering System.
It is important to read the manual before using the equipment.
Please keep manual in accessible place for future reference.

Manufacturer:

AOYUE INTERNATIONAL LIMITED

Jishui Industrial Zone, Nantou, Zhongshan City,

Guangdong Province, P.R.China

<http://www.aoyue.com>



This manual is designed to familiarize and instruct the operator with the proper usage and maintenance of the equipment. The "Care and Safety Precautions" section explains the hazards of using any type of soldering or reworking device. Please read carefully and observe the guidelines in order to maximize usage and minimize the risk of injury or accidents.

Product Description	4
Specifications	5
Package Inclusions	5
Safety Precautions	6
Control Panel Guide	7
Operating Guidelines	8 - 9
Auto-Sleep Functions	10
Digital Calibration	11 - 12
Care and Maintenance	13 - 17
Spare Parts List	18
Basic Troubleshooting Guide	19

PRODUCT DESCRIPTION

The Aoyue INT474A++ Advanced desoldering system has several advanced features such as digital calibration and configurable auto sleep. Its unique, innovative design with digital control panel and display provides precision, safety, and ease of use to match all reworking requirements.

Features:

- Microprocessor-controlled ESD safe equipment.
- Digital control and display of temperature with touch type panel controls for precision and ease of use.
- Equipped with air cylinder type vacuum pump for stronger suction and zero-crossing circuit that prevents electrical surges.
- User configurable 1 to 60 minute idle-to-auto-sleep mode for additional device protection and power saving.
- Digital calibration for easy temperature calibration
- With different desoldering tips.

SPECIFICATION

MAIN STATION	
Power Input :	available in 110V / 220V
Station Dimensions:	188(w) x 126(h) x 250(d) mm
Weight:	5.3kg
DESOLDERING GUN	
Power Consumption:	65-70W
Temperature Range:	200°C - 480°C
Heating Element:	Ceramic Heater
Output Voltage:	24V

Specifications are subject to change without prior notice.

PACKAGE INCLUSIONS

1 unit	474A++ Main Station
1 pc.	B1002A Desoldering Gun with 301212 tip (1.8mm)
1 pc.	201252 Spring Filter
1 pc.	30201X Suction/Vacuum Cover
1 pc.	201412 Desoldering Gun Holder
2 pcs.	30181X Black Filter Pads
1 pc.	Instruction Manual
1 pc.	302082 Desoldering Tip (1.0mm)
1 pc.	302092 Desoldering Tip (1.5mm)
1 pack	3017J Filter Pads (6pcs.)
1 pc.	3024X Spring Filter Cap
1 pc.	201242 Cleaning Pin
1 pc.	20178 Cleaning Drill
1 pc.	H022 Cleaning Gel
1 pc.	Power Cord

SAFETY PRECAUTIONS

CAUTION: Improper usage can cause serious injury to personnel and/or damage to equipment. For your own safety, please observe the ff. precautions.

- Check each component after opening the package to make sure everything is in good condition. If there are any suspected damage, do not use the item and report the issue to your vendor.
- Turn OFF the main power switch and unplug the device when moving the device from one location to another.
- Do not strike or subject the main unit to physical shock. Use carefully to avoid injury and damage to any part.
- Handle with care.
 - Never drop or sharply jolt the unit.
 - Contains delicate parts that may break if the unit is dropped.
- Make sure the equipment is always grounded. Always connect power to a grounded receptacle.
- Temperature may reach as high as 480°C when switched ON.
 - Do not use the device near flammable gases, paper and other flammable materials.
 - Do not touch heated parts, which can cause severe burns.
 - Do not touch metallic parts near the tip.
- Disconnect the plug from the power source if the unit will not be used for a long period.
 - Turn off power during breaks, if possible.
- Use only genuine replacement parts.
 - Turn off power and let the unit cool before replacing parts.
- The unit may produce a small amount of smoke and unusual odor during initial usage. This is normal and should not yield any negative result when reworking.
- Soldering process produces smoke — use on well ventilated place.
- Do not alter the unit, specifically the internal circuitry, in any manner.

CONTROL PANEL GUIDE

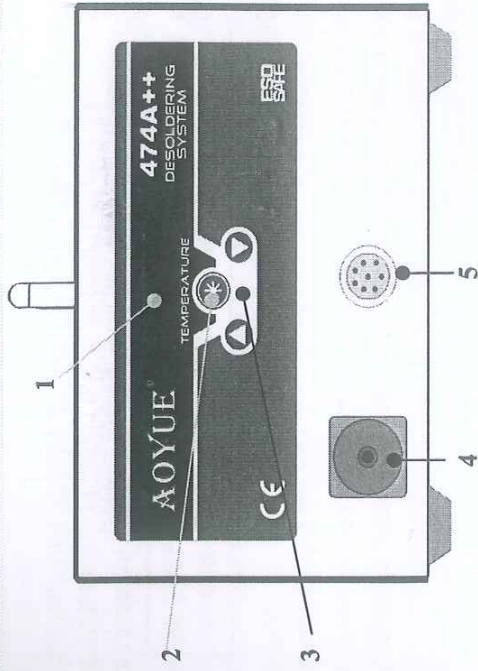

LEGEND:

- 1 — Desoldering Gun Temperature Display
- 2 — Desoldering Gun function button
- 3 — Desoldering Gun Temperature Control Buttons
- 4 — Vacuum Cap
- 5 — Desoldering Gun Receptacle

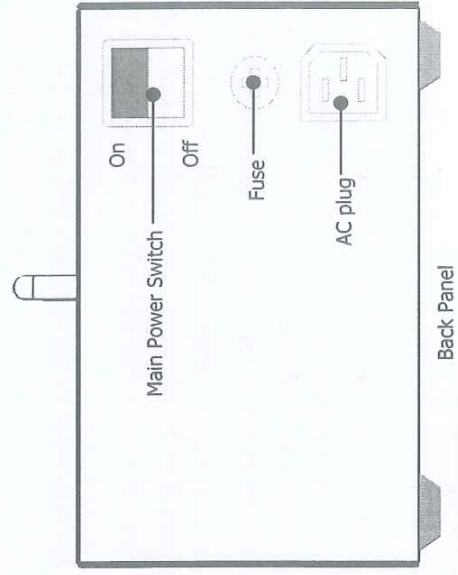

OPERATING GUIDELINES

A. MAIN STAION

As soon as the equipment has been removed from the package, **REMOVE THE SCREW** located at the center of the bottom of the main unit. This screw holds the pump in place during transportation.

 **WARNING:** Failure to remove the screw before using the equipment can cause damage to the system.

B. DESOLDERING GUN

1. Connect the cord of the desoldering gun to the desoldering gun terminal .
2. Connect the vacuum tube to the suction vacuum cap.
3. Place the desoldering gun onto the holder in preparation for usage.

IMPORTANT REMINDERS:

1. Make sure the equipment is placed on a flat stable surface and all the heat-generating components placed on their respective holders or stands.
2. Ensure all terminal connections are properly secured.

IMPORTANT: Please refer to the **CONTROL PANEL GUIDE** page for buttons and display panel directory.

C. DESOLDERING FUNCTION

1. Plug the device to the main power source using the power cord provided in the package.
2. Switch ON the device by activating the main power switch.
3. The display panel will show "OFF". The system will remain at this state until the user activates a function.
4. Connect the De-soldering gun connection assembly to the 8-pin receptacle located at the front of the control panel ("5" from the CONTROL PANEL GUIDE).
5. Connect the vacuum tube to the Smoke Absorber Terminal or Vacuum Cap ("4" from the control panel).

OPERATING GUIDELINES

6. To activate the "DESOLDER GUN" function, press and hold the desoldering gun function button for 3 to 5 seconds ("2" from control panel). The de-soldering gun temperature display will momentarily show the current set temperature then switch to displaying the actual temperature.
7. Adjust the desoldering gun temperature using the DESOLDERING GUN TEMPERATURE ADJUSTMENT buttons ("3" from the control panel).
8. Allow the desoldering gun's tip and its barrel to heat up. Tip temperature can be reached within 5-6 minutes and its barrel would obtain optimum temperature 5-9 minutes after the tip temperature has been reached. If upon initial use solder gets stuck at the end of the barrel, clean the barrel and wait a few more minutes for the barrel to heat up.
9. Check the tip temperature with an external temperature sensor, adjust temperature settings higher or lower for the right temperature. Or recalibrate at the desired temperature level
10. Ensure that all the solder is melted before triggering the pump. (Partially melted solder will still be sucked up however it would clog the barrel).
11. Upon pressing the pump trigger, hold the trigger for 1 to 2 seconds longer, as larger lumps of solder may need a longer suction time to clear the barrel and go into the filter.
12. Clean the filter and dampen the sponge frequently during and after usage to allow better suction power.
13. To deactivate the desoldering gun function press and hold the desoldering gun function button for 3 to 5 seconds ("2" from control panel).

Note: There will be a slight drop in temperature display once the trigger of the desoldering gun is used. This is due to rapid intake of air in which temperature is significantly cooler than the desoldering gun tip. When the system detects this, it will automatically adjust the temperature to compensate for the temperature difference.

AUTO SLEEP FUNCTIONS

F. Auto-Sleep Mode

The sleep timer can be configured to power down the desoldering gun after a defined time. When in sleep mode three dashes " - - - " will be shown indicating that it is now in sleep mode. To reactivate the simply push its corresponding function or adjustment button.)

By default the system's sleep duration is 0 indicating the sleep timer is disabled. To activate the sleep function follow the procedures below.

Changing SLEEP Timer

1. With the desoldering gun function turned off. Simultaneously press and hold for 5 seconds the Desoldering Gun Function button and the Desoldering Gun Down button .
2. The Desoldering Gun Temperature Display ("1" from the control panel) . Will switch to "t00" indicating it is now in the gun sleep timer adjustment mode.
3. Use the Desoldering Gun Temperature Adjustment buttons ("3" from the control panel) to increase or decrease the sleep duration. Timer is adjustable from 1 to 60 minutes, a value of 0 indicates that the sleep timer function is turned off.
4. Confirm the change by pressing and holding the Desoldering Gun Function button ("2" from the control panel).

DIGITAL CALIBRATION

H. Utilizing Digital Temperature Calibration

By default, the system is properly calibrated but for some cases when a little adjustment of the desoldering gun temperature is required the following procedure can be done.

1. Turn on the desoldering gun function.
2. Set to appropriate temperature you want to calibrate. Place the tip of the desoldering gun on an external temperature meter.
3. The readings on the external temperature sensor should be more or less equal to the displayed temperature.
4. If there are large discrepancy in the temperature reading we can re-calibrate the temperature setting. First write down the set temperature of the soldering iron and the actual temperature reading from the external temperature meter. For example:
set temperature = **300**
external temperature = **350**
Calibration needed = **-50**
5. Turn off the Desoldering Gun Function. Simultaneously press and hold for 5 seconds the Desoldering Gun Function button and the Desoldering Gun Up button .
6. The Desoldering Gun Temperature Display ("1" from the control panel) . Will switch to "000" indicating it is now in the desoldering gun digital calibration adjustment mode. The calibration range is from "-50" to "050" . The leading "-" sign signifies a negative calibration number while the leading "0" signifies a positive calibration number.
7. Use the Desoldering Gun Temperature Adjustment buttons ("3" from the control panel) to increase or decrease the calibration number. In our example the set temperature is 300 but the actual temperature is 350, There is need to decrease the temperature by 50 degrees. Press the down button until we reach "-50" .
8. Save the value by pressing and holding the Soldering Iron Function button ("2" from the control panel).

DIGITAL CALIBRATION

Digital Temperature Calibration Example 1

- The external temperature sensor displays 250 degrees.
- The set temperature and displayed actual temperature of the soldering iron is 300 degrees.
- $300 - 250 = 50$. An additional adjustment of 50 degrees is required. Upon entering calibration mode, the display shows "010", indicating a calibration number of 10 is already present.
- Therefore $10 + 50 = 60$.
- We adjust from "010" to "060" by pressing the up adjustment button.
- Save and exit calibration mode.
- The external temperature sensor would now display 298 to 302.

Digital Temperature Calibration Example 2

- The external temperature sensor displays 300 degrees.
- The set temperature and displayed actual temperature of the soldering iron is 350 degrees.
- $300 - 350 = -50$. An additional adjustment of -50 degrees is required. Upon entering calibration mode, the display shows "010", indicating a calibration number of 10 is already present.
- Therefore $10 - 50 = -40$.
- We adjust from "010" to "-40" by pressing the down adjustment button.
- Save and exit calibration mode.
- The external temperature sensor would now display 298 to 302.

NOTES:

- Calibration will only make the newly calibrated point the most accurate. Other temperature points may be a little off.

CARE and MAINTENANCE

Vacuum Air Terminal Filters

Filters should be cleaned and replaced regularly to avoid dirt which can clog the air passage. More importantly, this will also effectively clean the toxic fumes produced during soldering process.

De-Soldering Gun

1. Before usage dampen the filter pads with a little bit of water to allow efficient air passage and filter action, re-dampen pads frequently for maximum efficiency.
2. Routinely clean Spring Filter, and replace filter pads when they are dirty or clogged.
3. The solder pathway can be cleaned using the provided Nozzle cleaning pin, use the cleaning pin when pathway seems clogged.
4. Desoldering Gun's sensor connection with the main unit is faulty/ not connected. The device will display "Gun". Indicating a problem with the contacts of the soldering iron or the tip.
5. Desoldering Gun heating element has reached the end of its life, the temperature would consistently display a low value followed by "Err" display. Indicating a problem with the heating element or a reversed sensor polarity.



Filter Pads



Spring Filter



Cleaning Pin

CARE and MAINTENANCE

De-Soldering Gun Disassembled illustration:

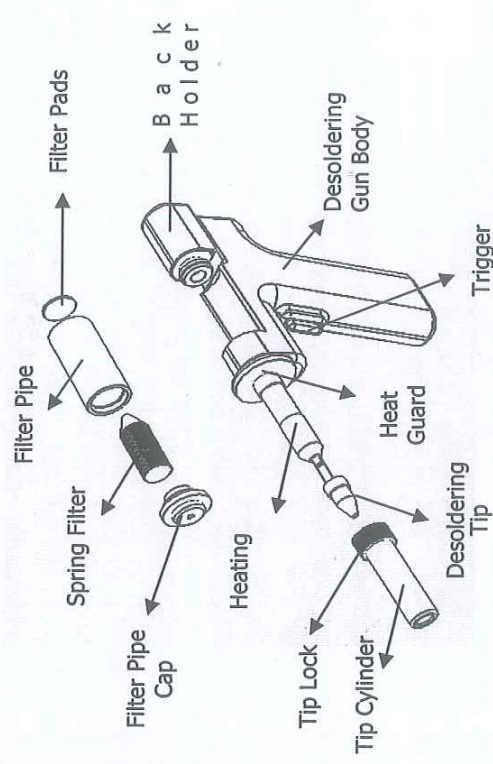

Changing Desoldering Tip:

1. Unscrew the Tip Lock and pull out Tip Cylinder together with the Tip Lock.
2. Pull out Desoldering Tip and replace with new one.
3. Re-secure nozzle by tightening the Tip Lock on its receptacle.

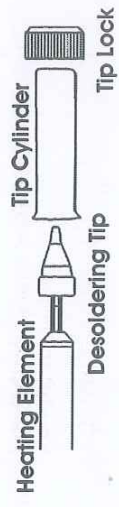

CARE and MAINTENANCE

Changing Filter Pad and Spring Filter:

1. Unlock the Filter Pipe by toggling the Release Knob. The Back Holder Assembly would spring back to allow easy extraction of the Filter Pipe Assembly which houses the Filter Pipe Cap, Spring Filter, Filter Pipe and Filter pad.
2. After extracting the Filter Barrel Assembly we can now take out the filter spring or the filter pads for cleaning or replacement.

Press down Release Knob to unlock Back Holder Assembly.

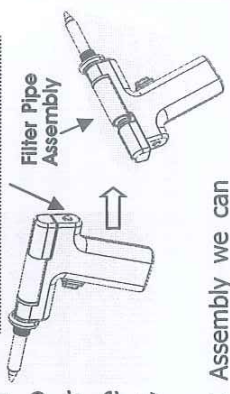

- If solder is collected in two-thirds of the spring filter replace the spring filter.
- Replace filter pad if stiff with flux and solder.

3. Re-assemble Filter Pipe Assembly, attach spring filter to the filter barrel cap and place back to the de-soldering gun body.

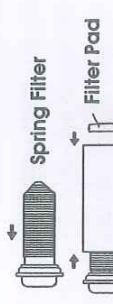
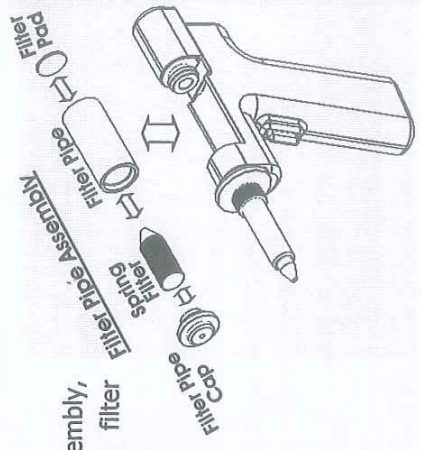

Attach the Filter Pipe Cap to the Filter Pipe so that it does not leak air.

4. Push the Back Holder Assembly back in place, a "click" sound would signify that the it is properly secured.

Firmly press the Back Holder Assembly into the Filter Pipe in order to properly seat front cap against the pipe.

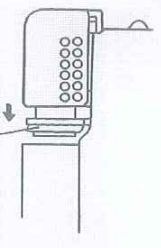

CARE and MAINTENANCE

▲ WARNING: Unplug the power cord before starting this procedure.

Replacing the Heating Element

1. Unscrew the Tip Lock and pull out Tip Cylinder together with the Tip Lock and remove Desoldering Tip.

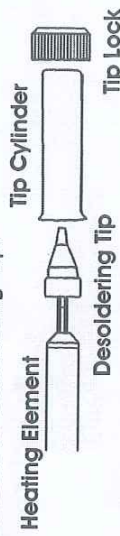

2. Remove the Filter Pipe Assembly.
3. Loosen the 3 fastening screws on the plastic handle and separate the housing.

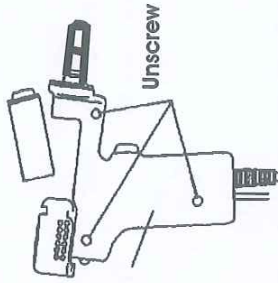

4. De-solder the heating element leads and sensor leads.
5. Detach the terminal and remove the heating element.
6. Insert a new heating element and solder.

Note:

- There is no polarity between leads of the same colors.
- Bend the leads at right angle to prevent short-circuit.

CARE and MAINTENANCE

Cleaning the Desoldering Tip

▲ CAUTION:

The desoldering gun will be extremely hot. During maintenance, please wear proper protection and work carefully.

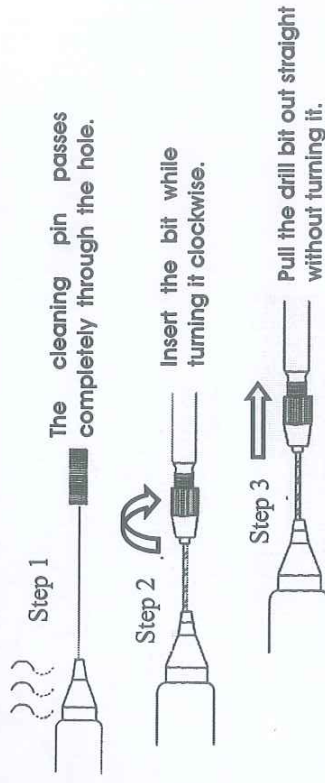

Using Cleaning pin:

Caution: Desoldering gun will be hot during maintenance please use proper materials and equipments to avoid injuries.

When suction efficiency has deteriorated the desoldering gun might be clogged follow these directions to properly clean the desoldering gun.

1. Turn on the desoldering gun and wait for the nozzle to heat up.
2. Slowly insert the cleaning pin while turning the cleaning pin clockwise.
3. Pull out the cleaning pin in a straight motion.
4. Repeat steps 2-3 until clog is removed.

- The cleaning pin will not pass through the nozzle until the solder inside the nozzle is completely melted.
- If the cleaning pin does not pass through the hole in the nozzle, clean with the cleaning drill.

Caution: If the cleaning drill is forced into the nozzle, the drill could break. Please use the proper sized cleaning pin or cleaning drill for the nozzle diameter. If the cleaning pin cannot pass through the hole, replace the Tip.

SPARE PARTS LIST

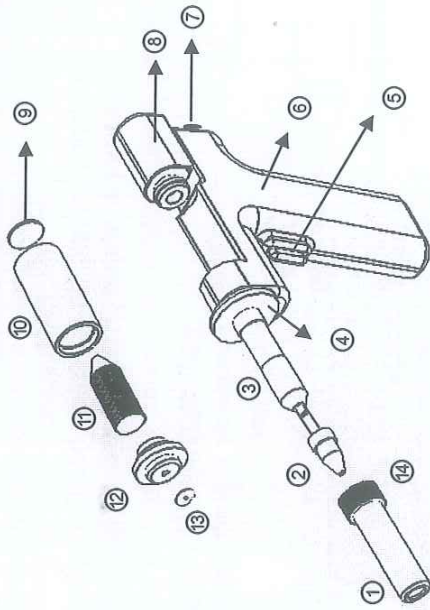

NO	Part No.	Part Name
①	30129	Desoldering Gun Tip Cylinder with Tip Lock
②	302082	Desoldering Tip 1.0MM
③	302092	Desoldering Tip 1.5MM
④	301212	Desoldering Tip 1.8MM
⑤	C005A	Desoldering Gun Heating Element
⑥	301282	Heat Guard Assembly
⑦	3021X	Red Release Knob
⑧	3072D	Desoldering Gun Outer Case
⑨	3074D	Desoldering Gun Outer Case
⑩	3021X	Release Knob
⑪	3035X	Back Holder Assembly
⑫	30180X	Filter Pad
⑬	3017J	Pack Of 6 Filter Pad
⑭	3022X	Filter Pipe
⑮	201252	Spring Filter
⑯	3024X	Filter Pipe Cap
⑰	3025X	Silicone Pad
⑱	20133	Tip Lock only

BASIC TROUBLESHOOTING GUIDE

PROBLEM 1: THE UNIT HAS NO POWER

1. Check if the unit is switched ON. Power switch located at the back.
2. Check the fuse. Replace with the same type if fuse is blown.
3. Check the power cord and make sure there are no disconnections.
4. Verify that the unit is properly connected to the power source.

PROBLEM 2: TEMPERATURE DISPLAY SHOWS "Gun"

Description: Desoldering gun digital display shows the message "Gun"

SOLUTION:

The desoldering gun connecting with the main unit is not detected. Reconnect desoldering gun terminal to the main unit. Sensor connection may be damaged, check for cord damage or sensor damage.

PROBLEM 4: THE UNIT IS VERY NOISY

SOLUTION:

Make sure the screw at the center of the base of the main unit has been removed. This holds the pump in place during transportation and needs to be removed before using the equipment.

PROBLEM 5: UNIT SHOWS UNCONVENTIONAL BEHAVIOR

Description: Unit operates erratically.

SOLUTION1: Try to switch OFF the device and switch ON again. Unplug the system from the main power source and plug in again when necessary

OTHER PROBLEMS NOT MENTIONED:

Contact the vendor.